

**exactcut**  
high performance circular saws

# *T-Serie*

*Efficiently. Reliably. Compact.*  
High performance circular saws

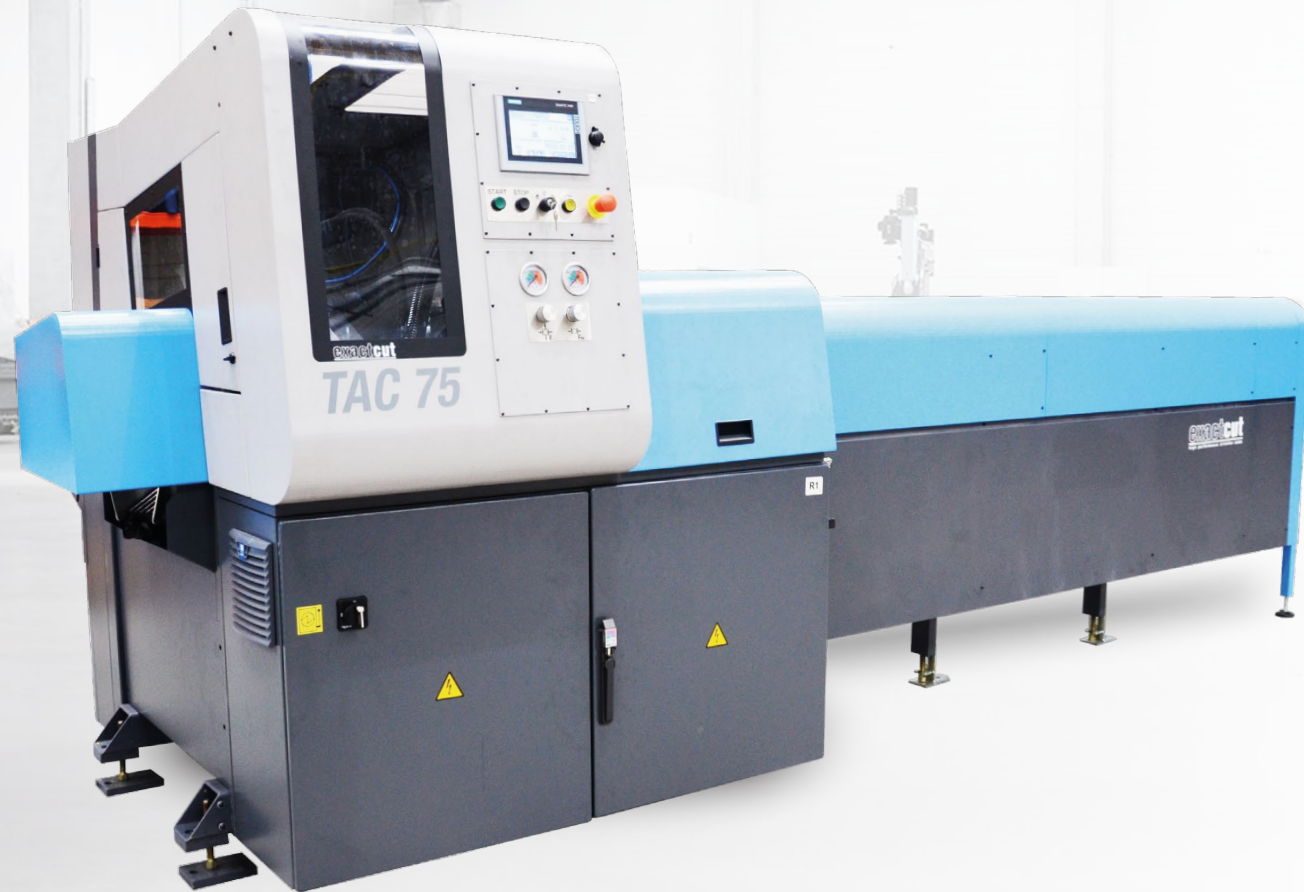



## Fast and Reliable

The new T-Series High Performance Circular Sawing Machines offer the easiest way into the world of high speed cutting. The 25° declined head on pre-tensioned linear guides with movement through a highly precise ballscrew and a well dimensioned servo motor, offer ideal performance on all materials. For lowest possible vibrations and noise the extensive use of mineral cast guarantees best equals on bladeflife and longterm performance. The control surface in dialogue system allows easy and simple operation of the machine, despite all possible adjustments and values are available to finetune the cutting process. With the automatic loading magazine for material up to 6 m length, the T-Series machines are made to work as a fully automatic production unit.

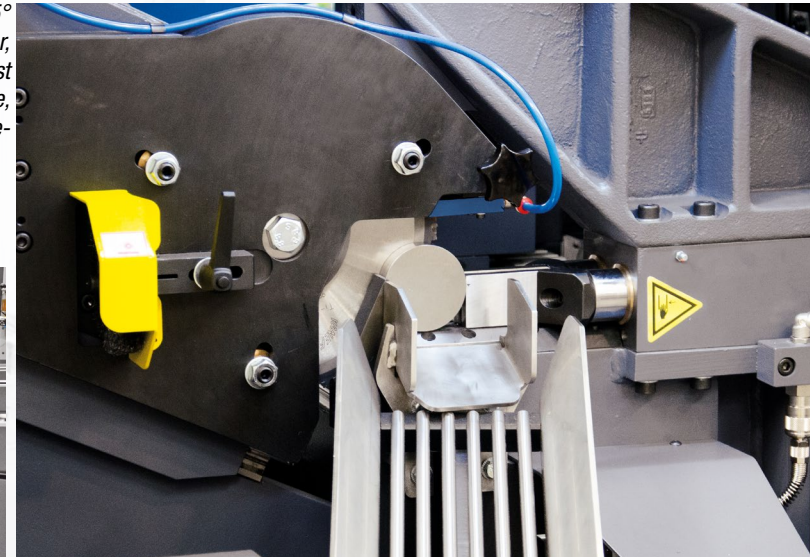

	<b>TAC 75</b>	<b>TAC 105</b>	<b>TAC 155</b>
Sawblade Size	Ø 250 / 285 mm	Ø 315 / 360 mm	Ø 360 / 425 / 460 mm
Cutting Capacity on round Material	Ø 10 - 75 mm	Ø 20 - 105 mm	Ø 30 - 155 mm
Blade Speed stepless adjustable	60 - 220 m/min <sup>-1</sup>	60 - 220 m/min <sup>-1</sup>	60 - 220 m/min <sup>-1</sup>
Restpiece length	60 mm	60 mm	70 mm
Main Drive Power	7,5 kW	11 / 15 kW	15 / 18,5 kW
Cutting Feed	0 - 6000 mm/min	0 - 6000 mm/min	0 - 6000 mm/min
Feeding Length	600 mm	750 mm	750 mm
Max. Load Material Length	6300 mm	6300 mm	6300 mm
Max. Load Material Weight	3 t	5 t	5 t



*Output sorting table with chute*  
- possibility of simultaneous withdrawal of several pieces  
- robust design for heavy pieces  
- adjustable angle of inclination



*Swarf exhaustion*  
- particularly used when cutting sections of aluminium or other non-ferrous metals  
- filtration simultaneously entraps oil mist

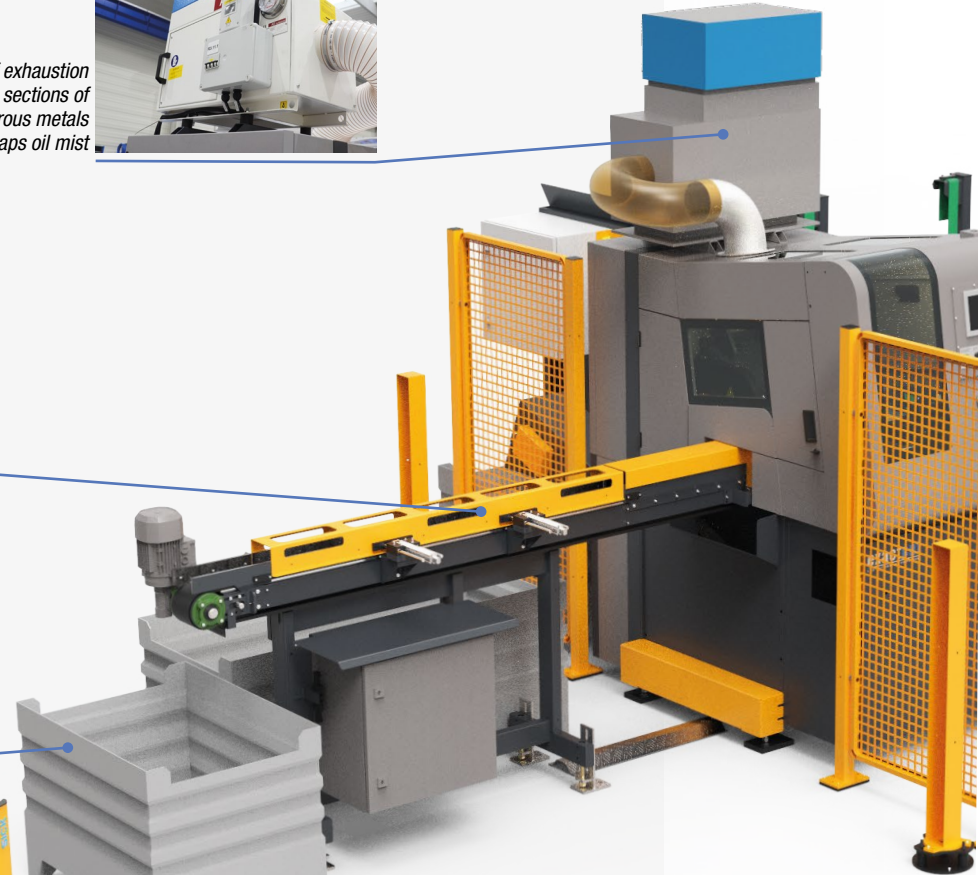

*Standard storage boxes provide uncomplicated handling workpieces*



## Ready for automation

Already in development of a each machine, we are thinking about its usefull in different conditions and in different productions. The TAC machine is ready to be a part of a huge automatic lines for complete production processes. You can easily extend the machine and connect the special parts as a material loading and feeding systems. This is the way we can turn the production proceses to the effective way.

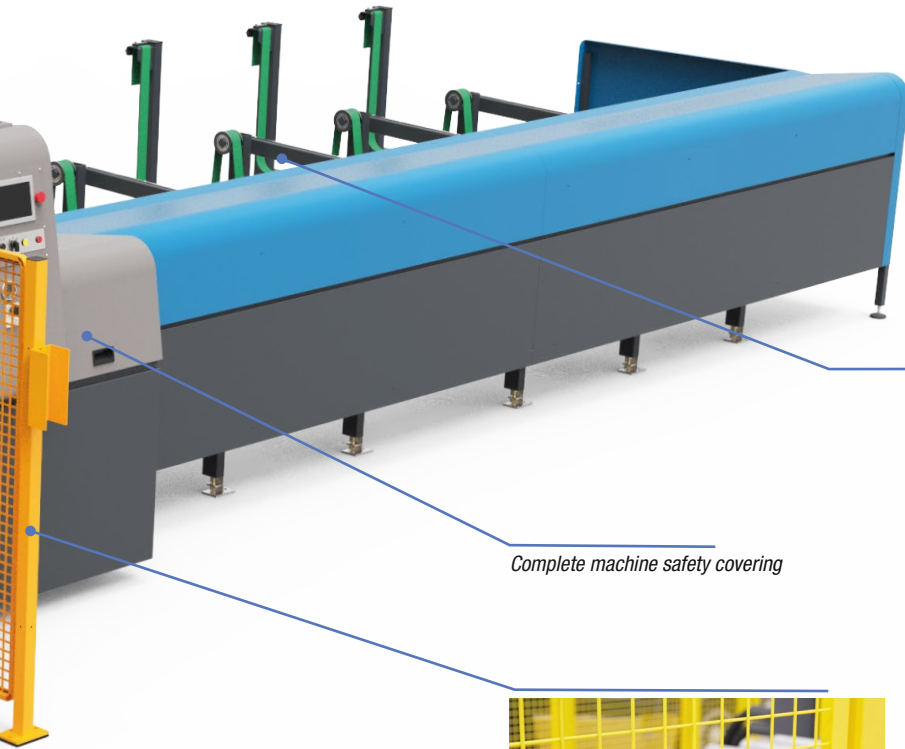

Complete machine safety covering



SECURFLEX security system - combined with lattice elements and laser light curtains



The auxiliary bundle feeder significantly simplifies the handling of material which is loaded and moved to the transverse feeder. It is particularly suitable for cutting in bigger lengths, when material has to be fed more often, and for handling bigger bundles. Personnel shall load a bundle of bars into the space with belts and move it from the bundle feeder using pushbuttons.

## Heavy and Rigid

All components are built heavy and rigid to guarantee sustainable productivity over the whole lifetime of the machine.

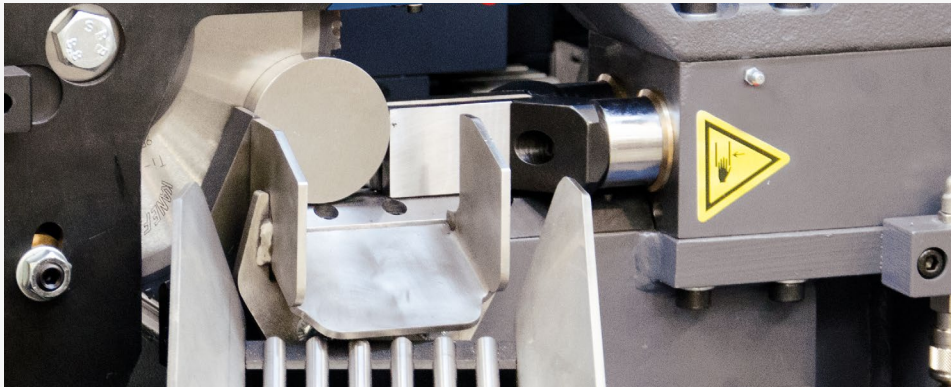

### Rigid High Force Clamping

The feeding vice is built for carrying the dedicated load with shortest possible acceleration and braking ramps for shortest cycle times.

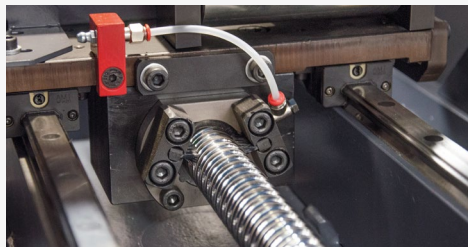

### Ballscrew and Linear Guiding

The precise ballscrew with a servo drive enables feeding rates up to 60 m/minute with highest possible precision.

### Laser Material Detection

Shortest cycle times afford minimum time in sensing. State of the art laser technology enables fast material detection on feeding.

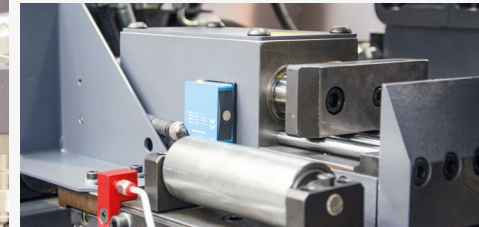

### Chip Brush included

Constant cleaning of the sawblade through a well adjustable wire brush results into longer bladeflife and better surface finish.

### Microspray Cooling

A micro spray system with a three-sided nozzle, placed directly above the cutting channel, covers ideal cooling of workpiece and blade.

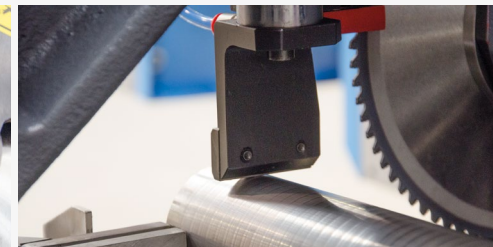
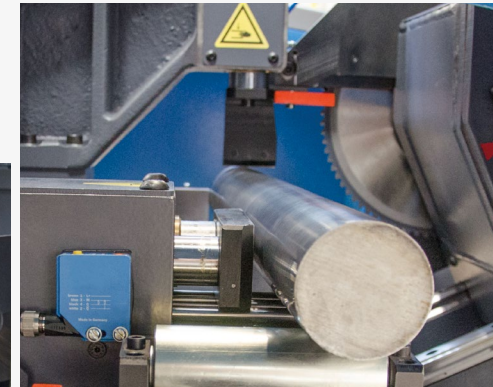
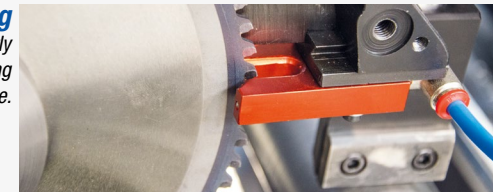

### Vertical Clamping

Strong and rigid vertical clamping gives additional hold to avoid any vibration during cutting process and guarantee precise results.

## Effective work with the material

Thanks to the special applications, the machine can be easily extended from regular performance circular saw to high performance cutting center.

### Sorting and storage by means of a robot

- automatic stacking and sorting of cuts into pre-defined positions
- possibility of passing cuts for further operations
- various principles of robot grips
- high flexibility of usage

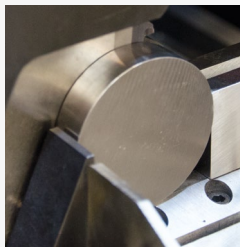
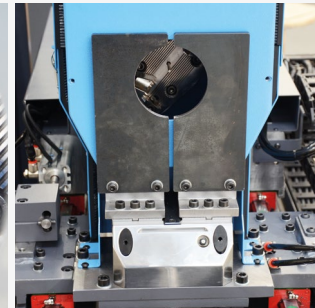
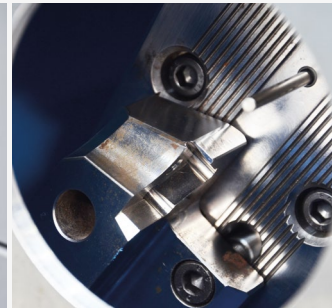

### Labeling device

- effective marking material for easier identification
- choice of numerical and alphanumeric markings
- easy connection

### End machining

- pre-defined chamfer shape of the end machined
- increased length accuracy
- Gühring company machining tools
- fully automatic operation

### ORBITAL material deburring

ORBITAL deburring machine serves for both-sided automatic deburring of bars and profiles of various diameters, shapes, and lengths.

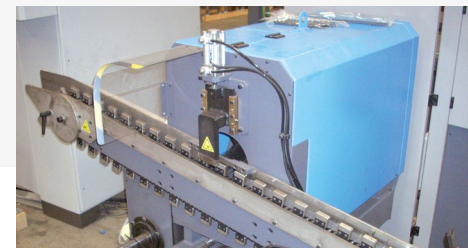
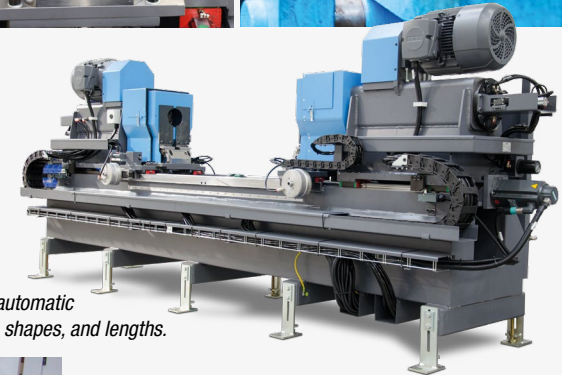

# **BEC** Solution Group

*Our company ExactCut, is a member of the BEC group, consisting of BOMAR sawing technology company and CTM drilling technologies. We would like to introduce ourselves as your new partner for all products in the group:*

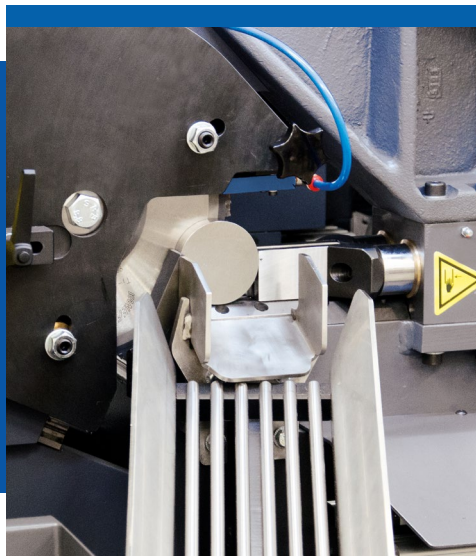

[www.exactcut.cz](http://www.exactcut.cz)